



The 6911 Keypad

HA469985U001 ISSUE 1

2007 Parker SSD Drives, a division of Parker Hannifin Ltd.

All rights strictly reserved. No part of this document may be stored in a retrieval system, or transmitted in any form or by any means to persons not employed by a Parker SSD Drives company without written permission from Parker SSD Drives, a division of Parker Hannifin Ltd. Although every effort has been taken to ensure the accuracy of this document it may be necessary, without notice, to make amendments or correct omissions. Parker SSD Drives cannot accept responsibility for damage, injury, or expenses resulting therefrom.

WARRANTY

Parker SSD Drives warrants the goods against defects in design, materials and workmanship for the period of 12 months from the date of delivery on the terms detailed in Parker SSD Drives Standard Conditions of Sale IA058393C.

Parker SSD Drives reserves the right to change the content and product specification without notice.

Product Manual

Safety Information



IMPORTANT Please read this information *BEFORE* installing the equipment.

Intended Users

This manual is to be made available to all persons who are required to install, configure or service equipment described herein, or any other associated operation.

The information given is intended to highlight safety issues, and to enable the user to obtain maximum benefit from the equipment.

Application Area

The equipment described is intended for industrial motor speed control utilising AC induction, AC synchronous machines or DC machines.

Personnel

Installation, operation and maintenance of the equipment should be carried out by qualified personnel. A qualified person is someone who is technically competent and familiar with all safety information and established safety practices; with the installation process, operation and maintenance of this equipment; and with all the hazards involved.

Safety

All control and signal terminals are SELV, i.e. protected by double insulation.

EMC

In a domestic environment this product may cause radio interference in which case the user may be required to take adequate counter-measures.

This equipment contains electrostatic discharge (ESD) sensitive parts. Observe static control precautions when handling, installing and servicing this product.

Safety Information



CAUTION!

- At any time, there may be a loss of motor control and as such separate/independent application measures should be taken to ensure that such loss of motor control cannot present a safety hazard.
- Remove power before inserting or removing the memory card.

RISK ASSESSMENT

Under fault conditions, power loss or unintended operating conditions, the drive may not operate as intended. In particular:

- Stored energy might not discharge to safe levels as quickly as suggested, and can still be present even though the drive appears to be switched off
- The motor's direction of rotation might not be controlled
- The motor speed might not be controlled
- The motor might be energised













A drive is a component within a drive system that may influence its operation or effects under a fault condition. Consideration must be given to:

- Stored energy
- Supply disconnects
- Sequencing logic
- Unintended operation

WARNING

**The Keypad contains a non-replaceable, rechargeable Lithium battery.
The limitations applied to the product's environment and use should be strictly followed.**

Contents

The 6911 Keypad.....	5			
Features	5			
Connecting The Keypad	6			
• Initial Power-Up	6			
Control Keys and LED Indications	7			
• Control Key Definitions	7			
• LED Indications	8			
The Display Screen	9			
The Multi-Keys	10			
• Multi-Key SET 1	11			
• Multi-Key SET 2	12			
• Multi-Key SET 3	14			
• Multi-Key SET 4	19			
Power-Up Key Combinations	25			
• Resetting to Factory Defaults (2-button reset)	25			
• Changing the Product Code (3-button reset)	26			
Remote Mounting the Keypad	28			
Fitting the Remote 6911 Keypad	28			
• 6052 Mounting Kit Parts for the Remote Keypad	28			
• Assembly Procedure	29			
Technical Specifications	30			
Returning the Unit to Parker SSD Drives	32			
Disposal	32			

The 6911 Keypad

The 6911 Keypad, part number 6911/01/00, is a plug-in MMI (Man-Machine Interface) option that provides local control of the drive, monitoring, and complete access for application programming.

It can be used with a wide range of Parker SSD Drives' products including the 590+, 605, 650V (Frames C-F), 650 (Frames 1-3 if fitted with an RS232 port), 690+ and 890 drives.

NOTE The 6911 keypad cannot mount on the front of the 605A drive, however it can be remotely mounted to the 605A drive.

It directly replaces the previous 6901 Keypad, and offers increased functionality.



6901
Keypad

Features

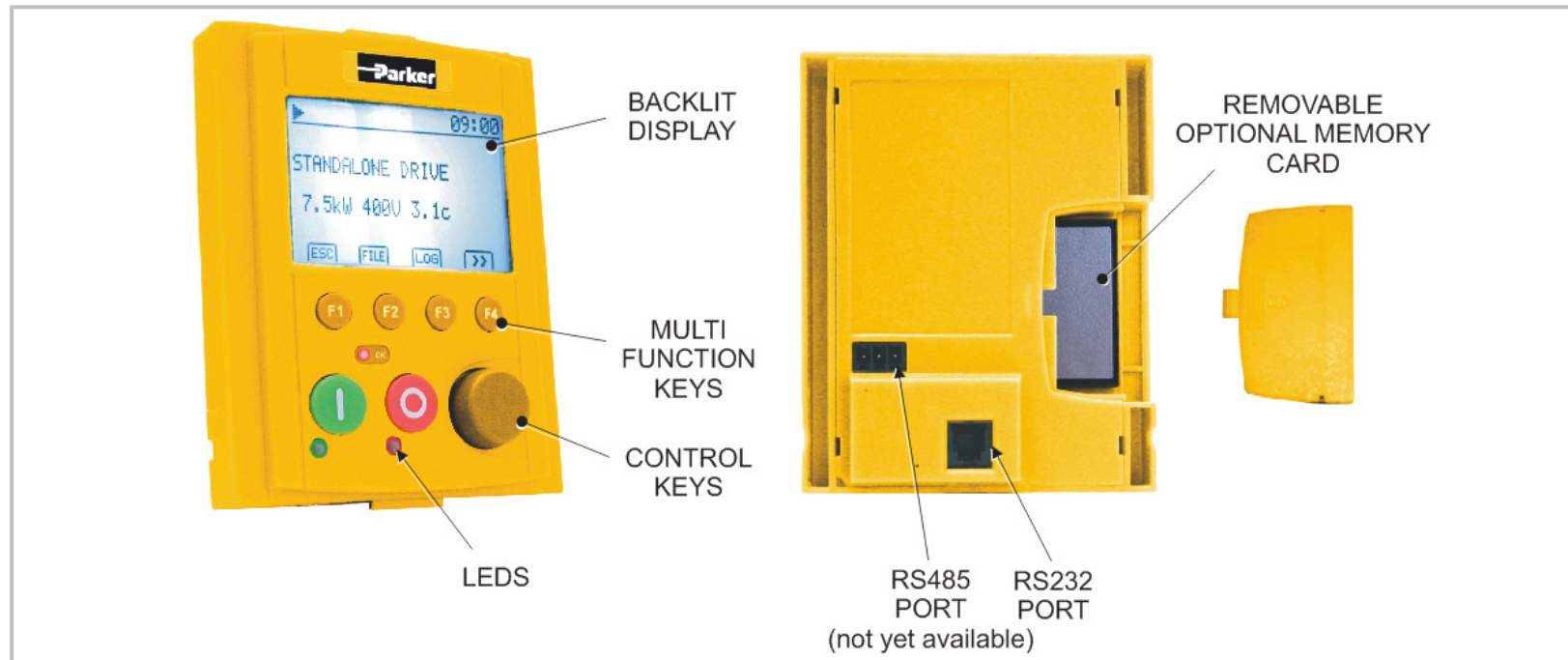

The 6911 Keypad

Connecting The Keypad

Insert the Keypad into the front of the drive or mount it up to 3 metres away using the optional panel mounting kit with the RS232 connecting lead. Refer to "Remote Mounting the Keypad", page 6-28.

On some drives, two Keypads (or one and a PC running suitable programming software) can be used simultaneously. In this case each Keypad runs independently.

The drive can operate in one of two modes:

Remote Control Mode: Allowing access for application programming using digital and analog inputs and outputs

Local Control Mode: Providing local control and monitoring of the drive using the Keypad, or PC running suitable programming software

Local control keys are inactive when Remote control mode is selected and vice versa, with one exception - the **L/R** selection on Multi-Key 2, Set 2 toggles the Local or Remote control mode and so is always operative.

Initial Power-Up

On power-up, a default logo-screen is displayed for several seconds showing the "Parker SSD" logo. If the display does not light, or a "comms code" is presented then there is a connection error.



Future MMI software versions will allow the "Parker SSD" logo-screen to be replaced with an image of your choice. This image can also be set as the timeout-screen and will appear after a preset time of keypad inactivity.

After the logo-screen, the display shows the product description; power rating, voltage and software version of the drive. A typical example is shown opposite.



Control Keys and LED Indications

Control Key Definitions

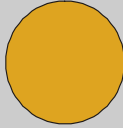
<p style="text-align: center;">RUN</p> 	<p style="text-align: center;">STOP/ RESET</p> 	<p style="text-align: center;">ROTARY CONTROL</p> 
<p><i>Control</i> - Runs the motor at a speed determined by the LOCAL SETPOINT or REMOTE SETPOINT parameter.</p> <p><i>Trip Reset</i> - Resets any trips and then runs the motor as above. Only operates when the drive is in Local Start/Stop (Seq) mode.</p>	<p><i>Control</i> - Stops the motor. Only operates when the drive is in Local Start/Stop (Seq) mode.</p> <p><i>Trip Reset</i> - Resets any trips and clears displayed message if trip is no longer active.</p> <p><i>650 Drive only</i> - press and hold to toggle between Local and Remote control modes</p>	<p><i>Programming</i> - (Endless) turning of the rotary control increments/decrements parameter values, or ascends/descends menu lists</p> <p>The rotary control is also a push-switch. It is used to select parameters and/or menus.</p>



RUN KEY STOP KEY ROTARY CONTROL

LED Indications

The LEDs indicate the status of the drive. Each one can operate in one of three different ways: OFF, FLASH and ON.

The RUN and STOP LEDs are physically associated with the RUN and STOP control keys. The LED marked "OK" indicates the HEALTH of the drive. Combinations of these LEDs have the following meanings:

RUN (green)	HEALTH (red)	STOP (red)	Drive State
FLASH	FLASH	FLASH	Re-Configuration
OFF	FLASH	ON	Tripped
OFF	ON	ON	Stopped
OFF	ON	FLASH	Stopping
FLASH	ON	OFF	Running with zero speed demand or enable false or contactor feedback false
ON	ON	OFF	Running
FLASH	ON	FLASH	Autotuning
FLASH	FLASH	ON	Auto Restarting, waiting for trip cause to clear
FLASH	FLASH	OFF	Auto Restarting, timing



The white display backlight can be configured to flash whenever the Health LED is flashing to provide a very visual alert (refer to "F2 : OPTIONS PAGE", page 14).

The Display Screen

After the start-up Logo Screen, the Keypad displays the Main View shown below.

To customise the screen refer to page 18

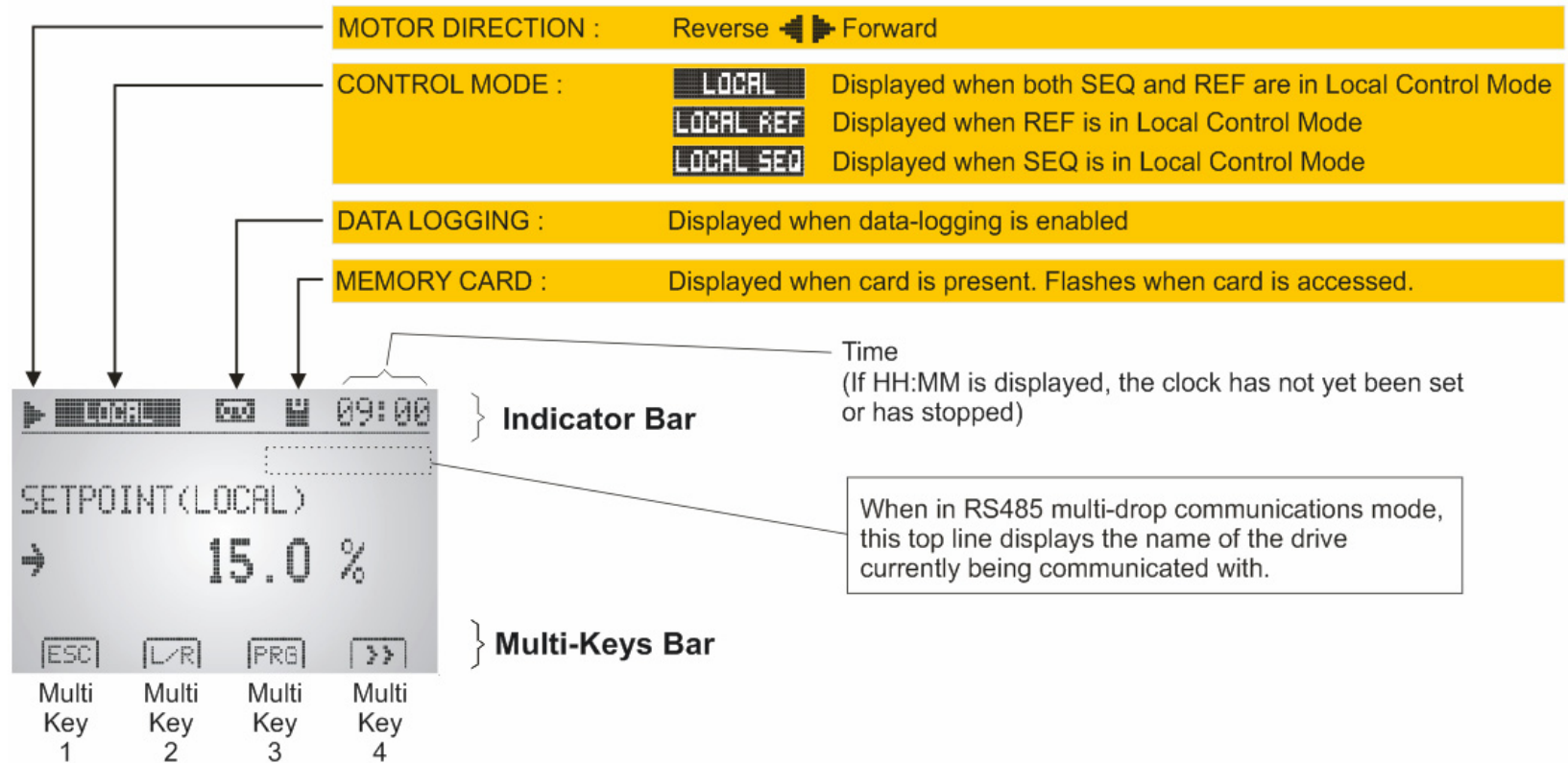

















Factory Default Main View

The Multi-Keys

The Multi-Keys provide access to four sets of functions. These are scrolled using function button F4.

NOTE If an alert event or local/remote toggle occurs whilst the keypad is displaying a configuration page (options "485 Setup", "File Browser", "Datalog Setup"), the MMI will revert to the Main View. Use Multi-Key 4 to return to the function page after the alert has been viewed.

SET 1				
	escape to higher menu level or return to parameter list	reverse motor direction (in Local Speed Control mode)	run at JOG SETPOINT speed (from "stopped" condition in Local Start/Stop mode)	next Multi-Key menu set
SET 2				
	escape to higher menu level or return to parameter list	toggle between Local/Remote control	toggle between current location in OPERATOR menu and any other menu	next Multi-Key menu set
SET 3				
	escape to higher menu level or return to parameter list	enter options page	enter RS485 address set-up page	next Multi-Key menu set
SET 4				
	escape to higher menu level or return to parameter list	enter memory card file browser page	enter data-logging set-up page	next Multi-Key menu set









The Rotary Control

The rotary control performs many of the functions provided by the soft keys.

Turning the rotary control moves the cursor up and down the page. Pressing the rotary control will select an item. It will also move the cursor within a pop-up window and select an item from that window.

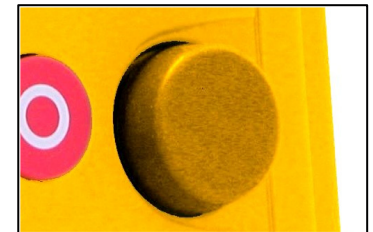





Multi-Key SET 1

F1 : ESCAPE

Press this to display the previous level's menu; or to return to the parameter list after editing a parameter. It is also used to acknowledge a displayed Trip or Error message.

F2 : FORWARD/REVERSE

This key changes the direction of motor rotation. It only operates when the drive is in Local Speed Control Mode.

Direction State	
	Requested direction and actual direction are forward
	Requested direction and actual direction are reverse
 (flash)	Requested direction is forward but actual direction is reverse (during slowing to reverse)
 (flash)	Requested direction is reverse but actual direction is forward (during slowing to reverse)

F3 : JOG

Press this key to run the motor at a speed determined by the JOG SETPOINT parameter. When the key is released, the drive returns to "stopped". This key only operates when the drive is "stopped" and in Local Start/Stop Mode.

F4 : NEXT MENU

Press this key to display next Multi-Key menu set.





Multi-Key SET 2

F1 : ESCAPE

Press this to display the previous level's menu; or to return to the parameter list after editing a parameter. It is also used to acknowledge a displayed Trip or Error message.

F2 : L/R

The L/R Multi-Key (LOCAL/REMOTE) toggles between Local and Remote Mode.

	Local/Remote Mode
OFF	Remote control of Start/Stop (SEQ) and Speed Control (REF) via the terminals
	Local control of Start/Stop (SEQ) and Speed Control (REF) via the Keypad keys and rotary controller
	Local control of Speed Control (REF) via the rotary controller Remote control of Start/Stop (SEQ) via the terminals
	Local control of Start/Stop (SEQ) via the RUN, STOP, JOG and  keys. Remote control of Speed Control (Ref) via the terminals

NOTE 650 Drive only - press and hold the STOP/RESET key to toggle between Local and Remote control modes.

NOTE A different naming convention is applied in the OPERATOR menu for these parameters when displayed as the first parameter entry:

- *REMOTE SETPOINT is displayed as SETPOINT (REMOTE)*
- *LOCAL SETPOINT is displayed as SETPOINT (LOCAL)*
- *COMMS SETPOINT is displayed as SETPOINT (COMMS)*
- *JOG SETPOINT is displayed as SETPOINT (JOG)*

Pressing the L/R Multi-Key when in Remote mode takes you directly to the SETPOINT (LOCAL) parameter with the Edit mode enabled. Press the PROG key to return to the previous display.

F3 : PROG

(This key does not function on 650 drives). The **PROG** Multi-Key toggles between the OPERATOR menu and any other menu, remembering and returning to previous positions in each menu. As you press the **PROG** Multi-Key, the title of the menu you are about to enter is displayed, i.e. OPERATOR or for example DIAGNOSTICS. Releasing the key clears the display and releases you into that menu.

Holding the PROG key for approximately three seconds will take you to the SYSTEM::SAVE CONFIG menu.

F4 : NEXT MENU

Press this key to display next Multi-Key menu set.

Multi-Key SET 3

F1 : ESCAPE

Press this to display the previous level's menu; or to return to the parameter list after editing a parameter. It is also used to acknowledge a displayed Trip or Error message.





Caution:

Stop the drive (system) before configuring the OPTIONS PAGE



Only drive alerts that affect the drive's health status will interrupt this configuration page.

F2 : OPTIONS PAGE

When the OPT page is selected, the soft keys are redefined, as shown below, for navigating and selecting whilst using the page.

			
Exit page, or exit OPTION setting list without changing anything	Row up (as Rotary Control clockwise action)	Row down (as Rotary Control anticlockwise action)	Edit setting, or exit OPTION setting list accepting all changes

During item selection or during setting selection mode, the soft keys are again redefined and function as follows:

			OK
Exit character edit without changing anything	Move the cursor left	Move the cursor right	Exit character edit and accept changes

With the Multi-Keys displaying SET3, press the "OPT" soft key to enter the Options Set-Up page.

There are more options than there are lines on the screen, so along the right-hand screen edge is a scroll bar to indicate the current position in the list, and the size of the list.

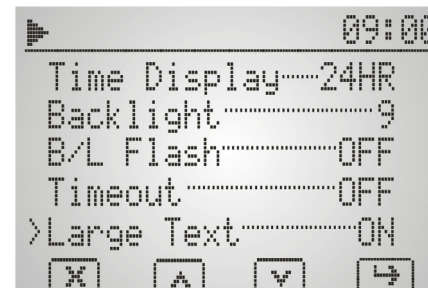

Options Set-Up Page			
Option Label Text	Optional Settings	Default Setting	Explanation
MMI Versi on	(read only)	not applicable	The display shows the firmware code version running in the MMI.
MMI Language	UK AUTO, FR, GR, SP, IT	UK	This option selects the display language. The AUTO setting uses the language of the host drive. (It is not reset when an MMI firmware upgrade is performed)
Connecti on	RS232 RS485	RS232	This option selects the MMI's mode of communicating with the drive (or drive system). RS232: requires a P3 lead connection to a single drive RS485: requires a 2-wire connection between the MMI's RS485 terminal and a drive using an RS485/RS232 converter Leave setting at RS232 for MMIs without RS485 functionality. See Caution opposite.
Configi Mem	INT TO MC	INT	This option selects the source/destination for transferring configuration files (or clone) between the drive and the MMI. INT: transfers are between the drive and the MMI's internal EEPROM. TO MC: transfers are between the drive and the MMI's Memory Card (option only offered if memory card is present). <i>Tip: If the MC file mode cannot be entered, the memory card is unusable. Try another one.</i> Only upload configuration files.

Note: AUTO, FR, GR, SP & IT are not yet available.

Caution:
Stop the drive (system) before making any changes to the mode of communication.

Options Set-Up Page			
Option Label Text	Optional Settings	Default Setting	Explanation
Time Display	OFF 24HR, 24HR+1 SET	24HR	This option adjusts the format and visibility of the real-time clock. Select 'SET' to adjust the time and date in the pop-up menu. 24HR+1 shows time adjusted for daylight, but does not act upon file time stamping.
Backlight	0 – 9 AUTO	9	This option sets the brightness of the display backlight, allowing you to match display brightnesses within a system: 0 = OFF; 1 =30%; 9 = 100%; AUTO changes from 1 to 9 on key (or encoder) activity, timing out after 30 seconds, considerably extending the working life of the MMI backlight.
B/L Flash	OFF ON	OFF	This option causes the display backlight to flash whenever the "OK" (health) LED flashes providing a high visibility alert. It stops flashing when the "OK" LED stops flashing, or at the first press of any key.
Timeout	OFF VIEW	OFF	This option adjusts the display after 30 seconds of key (or encoder) inactivity: VIEW : displays the bitmap timeout-screen until the next key press
Large Text	OFF ON	ON	This option enables large text for the primary parameter/diagnostic value, where possible.
Rotary Adj	OFF ON	ON	This option allows the rotary control action to be disabled on the drive menus. ON = ENABLED OFF = DISABLED Disable the rotary control to prevent accidental changes, for example: during datalogging. Multi-Key Set 2 (L/R & PROG) are replaced with ▲▼ keys (compatible with the 650 drive).

Caution:

Always disable the rotary control after drive commissioning if its accidental rotation would cause an unwanted adjustment or action.

F3 : RS485 PAGE (not yet available)

With the Multi-Keys displaying SET3, press the "485" Multi-Key to enter the RS485 Set-Up page.

The menu displays 15 drive names. In an RS485 system comprising several drives, the Keypad will control the selected drive (indicated by the arrow on the right of the screen). By default, 01 is selected. This number is the UID (Unit Identity Address).

Set the UID of each drive in the system to a unique value from 1 to 15. (The default value of UID for all Parker SSD drives is 0).

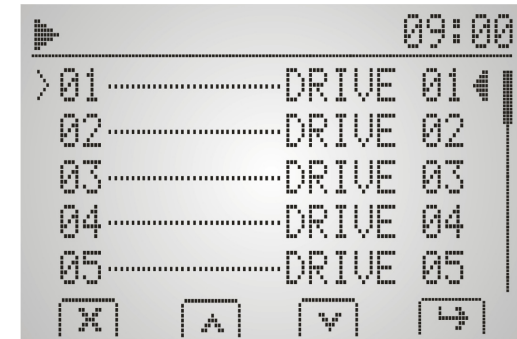

Caution:
Stop the drive (system) before configuring the RS485 PAGE.
 Only drive alerts that affect the drive's health status will interrupt this configuration page.

Drive	Value	Parameter Address
605	Decimal	SETUP PARAMETERS::FUNCTION BLOCKS::SERIAL LINKS::SYSTEM PORT (P3)::UNIT ID (UID)
650 1-3 650V C-F	Decimal	CELITE : SETUP::COMMS PORTS::COMMS ADDRESS Keypad : SET::SERL::SE03
690+	Decimal	SETUP::COMMUNICATIONS::SYSTEM PORT (P3)::UNIT ID (UID)
590+	Hex	SERIAL LINKS::SYSTEM PORT P3::P3 SETUP::BISYNCH SUPPORT::UNIT ID (UID)
890		Keypad control via RS485 is not available on this drive.

NOTE Use the RS232 connection mode (P3 lead) when configuring the RS485 addressing, otherwise any address changes will interrupt the drive communication.

Now you can select a corresponding drive from the list by turning the Rotary Controller. The arrow on the left of the screen moves to show your selection. Press ESC to exit the "485" menu.

Press the Rotary Controller to select the drive. From the sub-menu, the following is possible:

LABEL

Enter a node label, PUMP 1 for example.

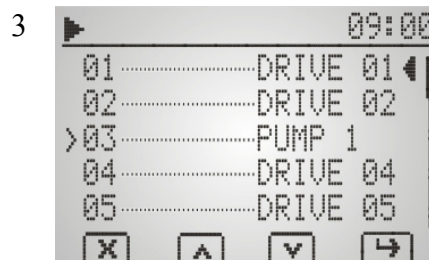
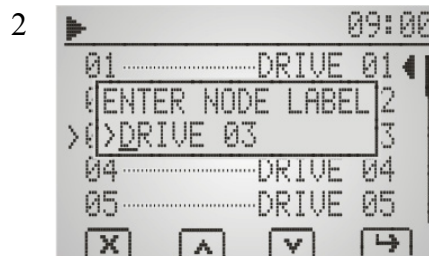
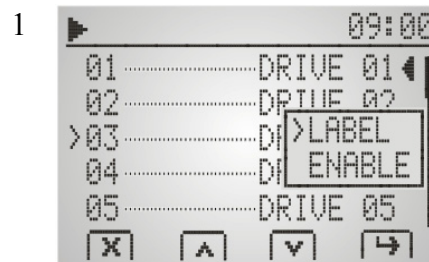

ENABLE

Enable the selected drive to be controlled by the Keypad. Note that the arrow on the right of the screen will highlight the new selection.

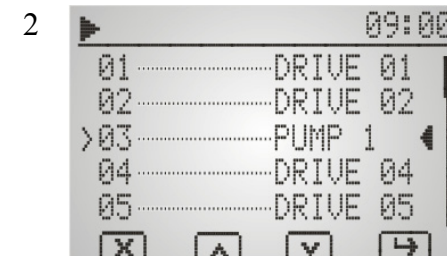
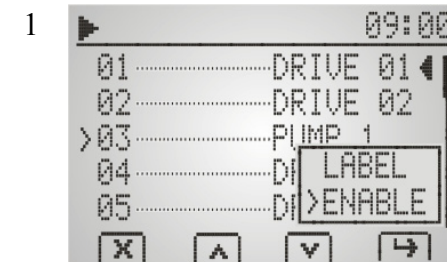

[>>] F4 : NEXT MENU

Press this key to display next Multi-Key menu set.

Multi-Key SET 4

F1 : ESCAPE

Press this to display the previous level's menu; or to return to the parameter list after editing a parameter. It is also used to acknowledge a displayed Trip or Error message.





Caution:

Stop the drive (system) before configuring the FILE BROWSER PAGE.



Only drive alerts that affect the drive's health status will interrupt this configuration page.

F2 : FILE BROWSER PAGE



When the FILE page is selected, the soft keys are redefined, as shown below, for navigating and selecting whilst using the page.

			
Exit page, or return to previous directory	Row up (as Rotary Control clockwise action)	Row down (as Rotary Control anticlockwise action)	Show available actions list for currently selected file, or open a folder

During item selection, the soft keys are again redefined and function as follows:

			OK
Exit character edit without changing anything	Move the cursor left	Move the cursor right	Exit character edit and accept changes

During a file action (loading etc.), the soft keys are again redefined and function as follows:

	
Decline action	Accept action

With the Multi-Keys displaying SET4, press the "FILE" soft key to enter the File Browser page.

- view the memory card contents
- upload new firmware code to the MMI

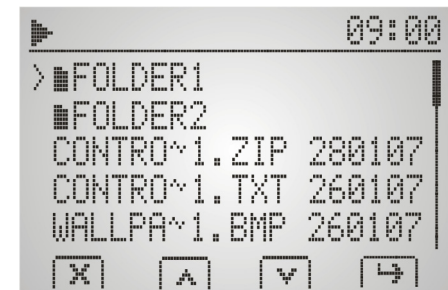

Example page

Select a file and press either the Rotary Control or the  Multi-Key to display the available actions for the selected file type. After completing a file transfer task, the screen returns to the main File Browser page.





File Type	Filename Extension	Available Actions	Action Description
MMI Firmware File	.BIN	Load new MMI code?	Selected file updates the MMI firmware. Only perform this procedure with the drive system stopped. The update is followed by an automatic MMI reset.

NOTE The files presented in the browser are presented in the order that they are listed on the memory card directory, and as a result, folders are not necessarily at the top of the list.



F3 : DATA LOGGING

Use this page to configure regular-interval, data-logging of the main display screen text.

When the FILE page is selected, the soft keys are redefined, as shown below, for navigating and selecting whilst using the page.

			
Exit page, or exit sub-menu declining changes	Row up (as Rotary Control clockwise action)	Row down (as Rotary Control anticlockwise action)	Display sub-menu, or accept changes

During item selection or during setting selection mode, the soft keys are again redefined and function as follows:

			OK
Exit character edit without changing anything	Move the cursor left	Move the cursor right	Exit character edit and accept changes

With the Multi-Keys displaying SET4, press the "LOG" soft key to enter the Data-Logging page.

How To Configure Data Logging

The menu is displayed in order of completion:

1. Name the file for use in data logging and insert the memory card that will store the file.
2. Select the trigger that will start the data logging, or select continuous data logging.
3. Set the time interval between the data logs.
4. Select the units for each time interval.
5. Enable data logging by setting continuous logging, or by entering the total number of samples to be made.

Disclaimer

Although every effort has been taken to ensure the accuracy of the data logging function, Parker SSD Drives cannot accept responsibility for damage, injury, or expenses resulting from the use of data logging.

Data-Logging Page			
Option Label Text	Optional Settings	Default Setting	Explanation
Log File Name	6911 USER	6911	<p>Select either the default filename "6911.LOG", or enter a user-filename for the data log.</p> <ul style="list-style-type: none"> When creating a new file, it is stored in the memory card's root directory. When using an existing file name, the new data is appended to the existing file.
Log Trigger	CONT HH:MM ALARM	CONT	<p>Select the trigger condition that will start the logging.</p> <p>CONT : Continuous logging without need for a start condition.</p> <p>HH:MM : If set to a time, e.g. 15:30, the logging will start at the clock time shown on the display.</p> <p>ALARM : Logging commences at the next dirve alert condition (causing a health status change).</p>
Interval	01 to 99	01	Set the number of time unit intervals between each log event.
Time Units	SEC MIN HOUR	MIN	Select the units of the time interval.

Data-Logging Page			
Option Label Text	Optional Settings	Default Setting	Explanation
Logging	OFF CONT 0000	OFF	<p>Enable/disable logging.</p> <p>OFF : Logging is disabled.</p> <p>CONT : Continuous logging is enabled.</p> <p>0000 : Enter sample count (counts down to zero, then stops). 0000 to 9999</p>

NOTE Changing the log filename, trigger interval or time units will disable logging if currently set.

If the logging mode cannot be changed from OFF, then the memory card is absent, is unusable, or the clock has not been set.

The log file output is a comma-separated text file, in the form of a table of data-log events, as illustrated.

6911 Data-Log File

```
Time format: ,DAY/MONTH/YEAR, HOUR.MIN.SEC
Logging trigger: ,TIME-09:18
Logging interval: ,02-SEC
```

```
09/01/07,09:18:00,DRIVE FREQUENCY , -8.4 Hz
09/01/07,09:18:02,DRIVE FREQUENCY , -20.6 Hz
09/01/07,09:18:04,DRIVE FREQUENCY , -32.9 Hz
09/01/07,09:18:06,DRIVE FREQUENCY , -35.1 Hz
09/01/07,09:18:08,MOTOR CURRENT , 0.1 A
09/01/07,09:18:10,DC LINK VOLTS , 337 V
09/01/07,09:18:12,SPEED SETPOINT , -74.8 %
09/01/07,09:18:14,DRIVE FREQUENCY , -37.4 Hz
09/01/07,09:18:16,DRIVE FREQUENCY , -37.4 Hz
09/01/07,09:18:18,DRIVE FREQUENCY , -30.4 Hz
09/01/07,09:18:20,DRIVE FREQUENCY , -22.7 Hz
09/01/07,09:18:22,DRIVE FREQUENCY , -10.5 Hz
09/01/07,09:18:24,DRIVE FREQUENCY , -2.8 Hz
09/01/07,09:18:26,DRIVE FREQUENCY , -1.0 Hz
09/01/07,09:18:28,DRIVE FREQUENCY , -0.4 Hz
09/01/07,09:18:30,DRIVE FREQUENCY , -0.1 Hz
09/01/07,09:18:32,DRIVE FREQUENCY , -0.0 Hz
```

Notes:

1. The first sample is taken at the point of the logging start condition.
2. A power interruption during the logging process results in the text “Power interruption may have affected Data Log” being added to the log file when power is resumed. The total number of log events, if in use, is not corrected for the down-time. A power interruption that occurs when a time trigger is set up will halt data logging.
3. Any change to the filename, trigger, or sample interval will halt data logging.
4. The file browser can be used during data logging.
5. Excessive MMI or memory card activity can delay data sample times if the interval is set very short.







F4 : NEXT MENU

Press this key to display next Multi-Key menu set.

Power-Up Key Combinations

At start-up, the 6911 Keypad is scanned for deliberate key-holding. The Multi-Keys are interpreted in the following way allowing for the power-up key combinations associated with all our drives. The interpretations refer to control keys on previous SSD Keypads, for example, the 6901 Keypad.

F1	Interpreted as the "UP" key	
F2	Interpreted as the "DOWN" key	
F3	Interpreted as the "E" key	
F4	Interpreted as the "PROG" key	



6901
Keypad

Resetting to Factory Defaults (2-button reset)

A special key combination restores to the drive the current product code default values and factory parameter values (refer to this section in the drive's Product Manual for details). This feature is only available at power-up as a security measure.

Hold down the keys opposite:

Power-up the drive, continue to hold for at least 2 seconds

RESTORE DEFAULTS
"UP" TO CONFIRM

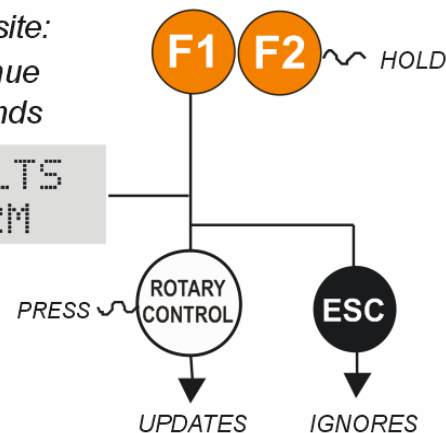

Changing the Product Code (3-button reset)

On rare occasions it may be necessary to change the default settings by changing the Product Code.

A special key combination is required to change the product code. This feature is only available at power-up as a security measure.

The 3-button reset will take you to the POWER BOARD menu in the expanded SYSTEM menu (highlighted in the diagram below).

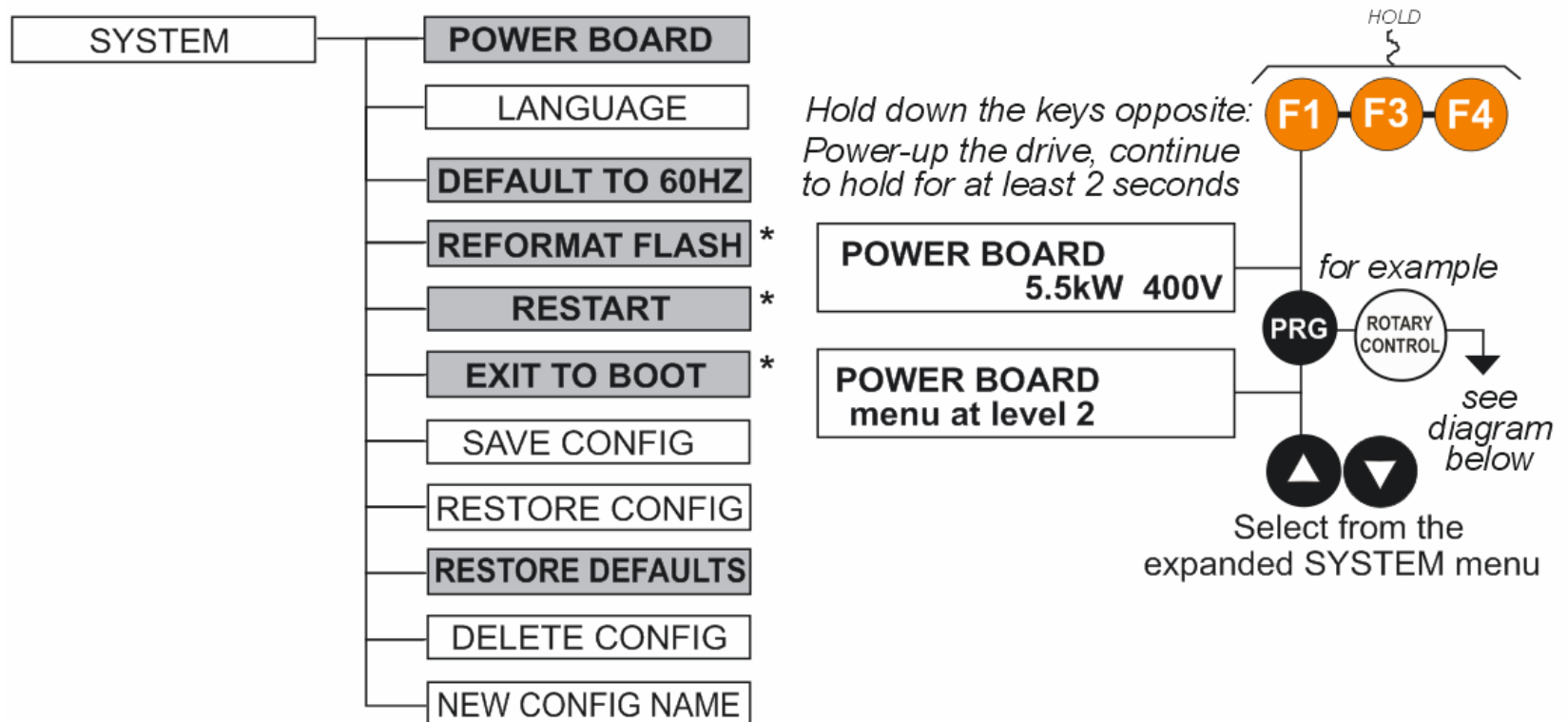

IMPORTANT We recommend the menus marked *above are only used by Parker SSD Drives or suitably qualified personnel.

POWER BOARD

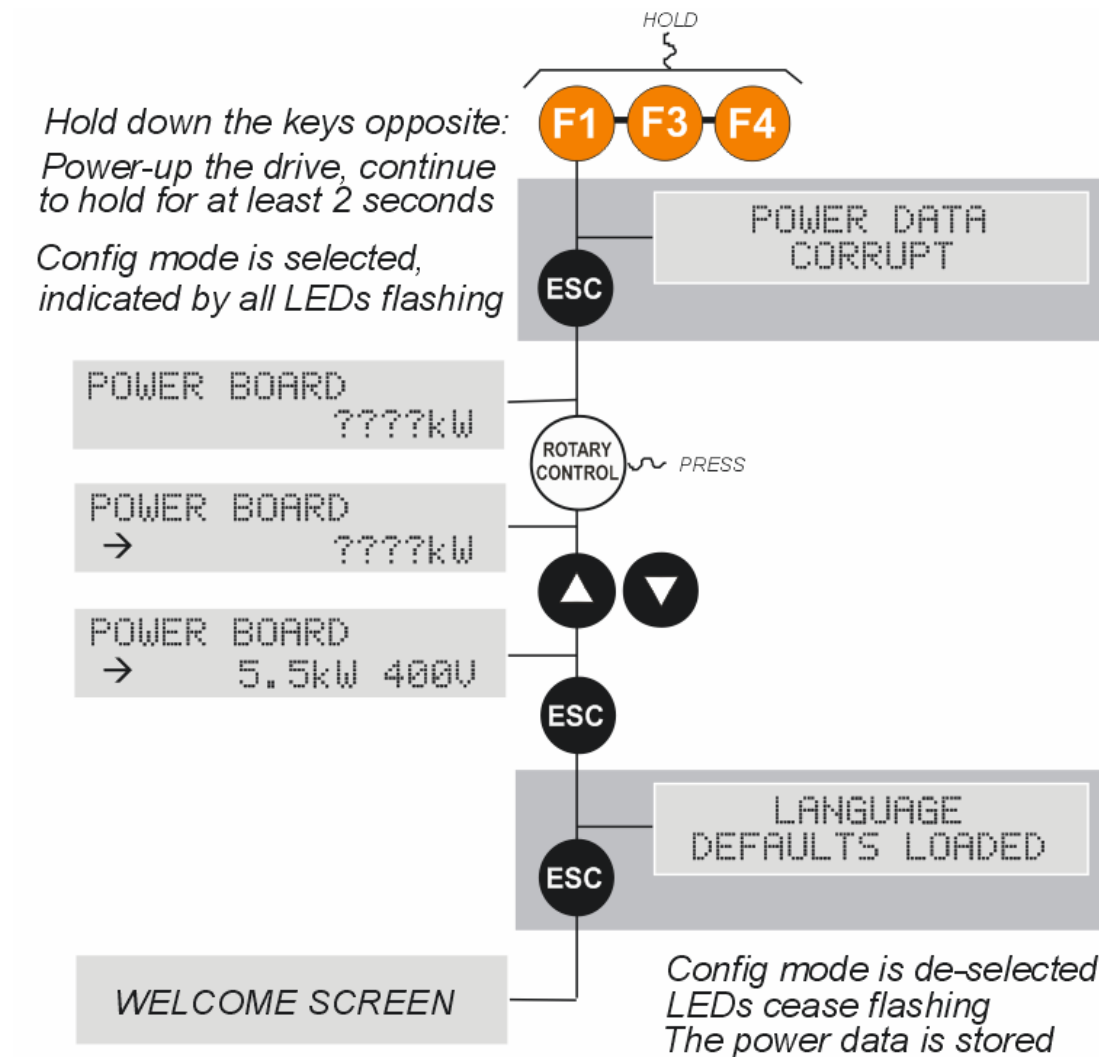

The diagram above shows a 3-button reset when there is no power data stored in the drive. If the drive has power data stored, then the “Power Data Corrupt” and “Language Defaults Loaded” alert messages will not be displayed, also the display will show the current power board selection, instead of “????kW ???V”.

Remote Mounting the Keypad

Fitting the Remote 6911 Keypad

The 6052 Mounting Kit is required to remote-mount a 6911 Keypad. The kit contains an RS232 connecting lead, and an RS485 connector. A No. 2 Posidrive screwdriver is required for installation.

6052 Mounting Kit Parts for the Remote Keypad

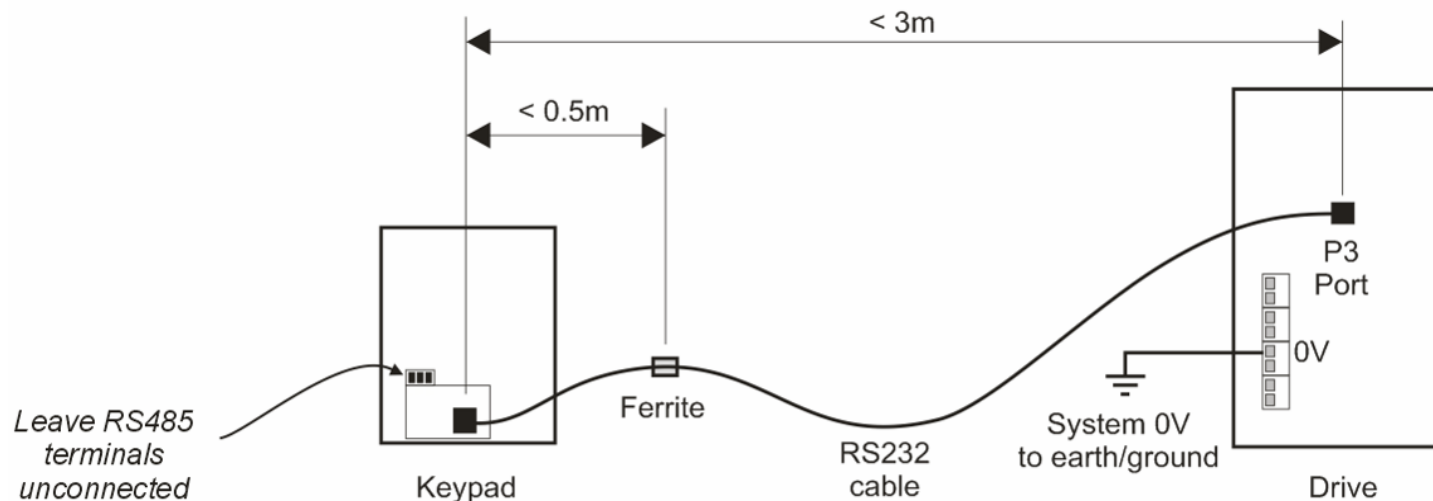
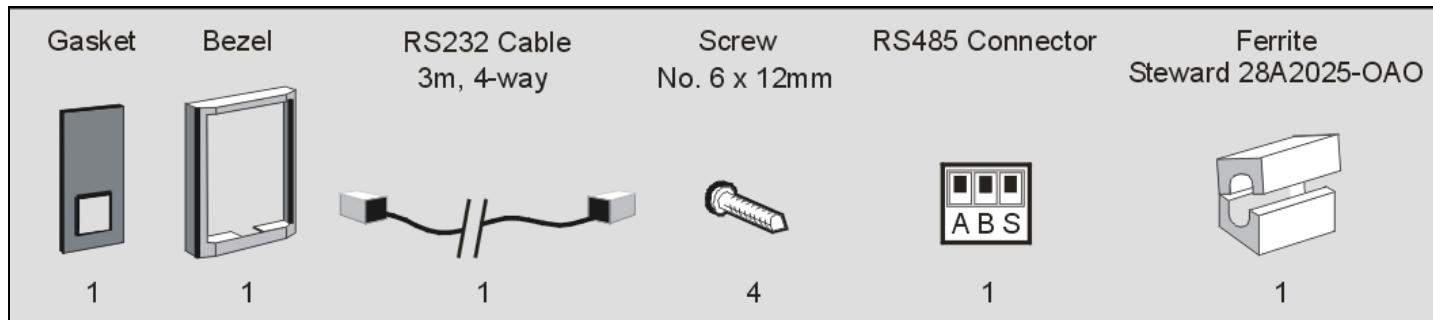

Assembly Procedure

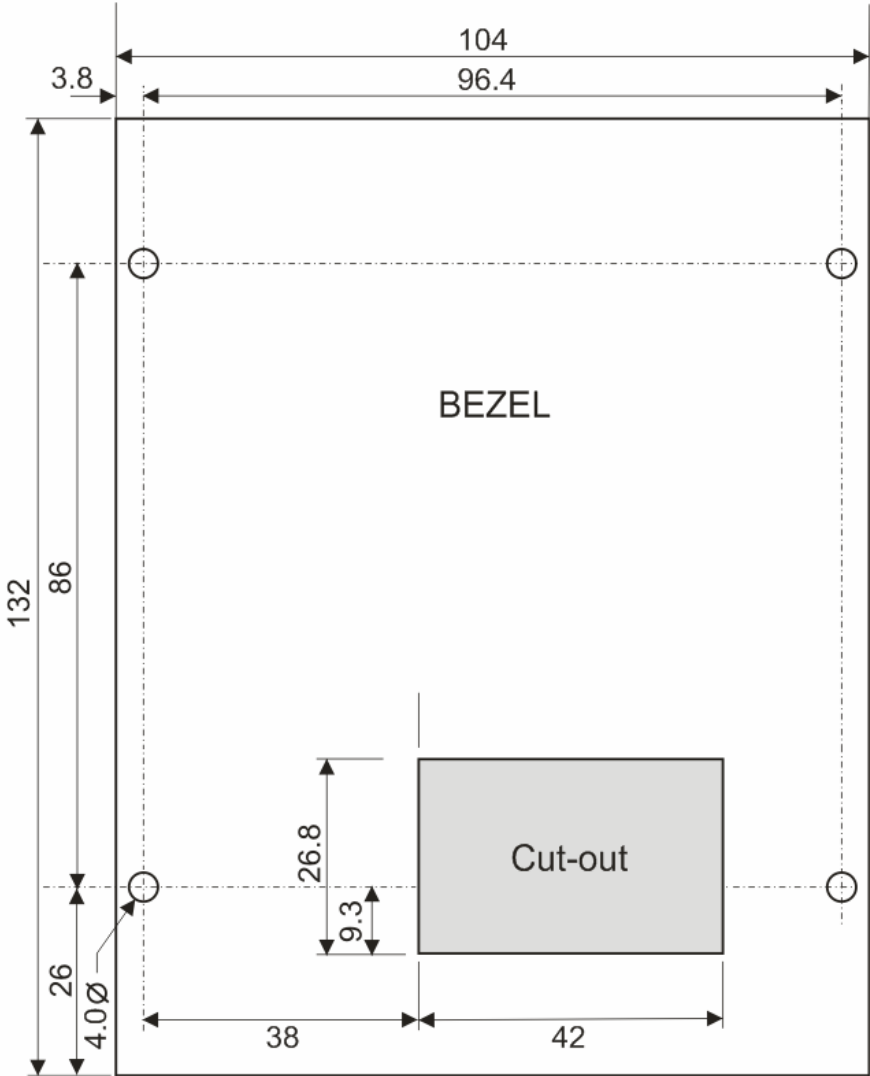
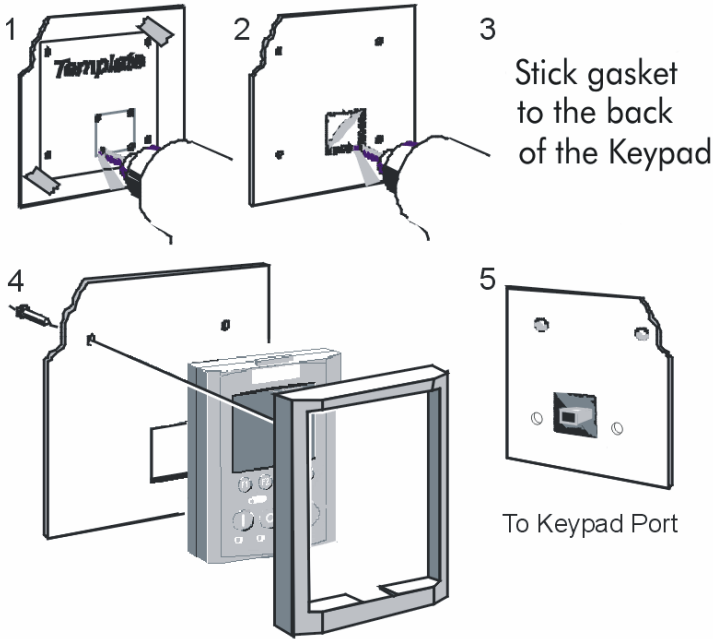

Mounting Dimensions for the Remote-Mounted 6911 Keypad

Technical Specifications

Liquid-Crystal Display	
Resolution	128 x 64 pixels
Backlighting	On state brightness adjustable from 30% at setting "1" to 100% at setting "9". 0 = OFF.
EEPROM Memory	
Size	8Kbytes
Function	Storage of one 690 or one 590 configuration.
Power Management	
Supply Voltage	5V dc (from RS232 port connection)
Current Consumption	100mA typical (0.5W)
MMI Hot-Pluggable	Yes
Real-time Clock	
Time Accuracy	Losing or gaining < 1 minute every 25 days @ 25°C, < 1 minute every 17 days @ 0°C - 50°C
De-Powered Time Back-Up	Provided by a lithium manganese dioxide cell, 3.0V 15mAh. Trickle charged during periods of MMI power-up.
Time Back-Up Duration	> 6 months de-powered.
Time Back-Up MMI Power-Up Duty	> 1% of time powered-up, for continuous RTC operation (i.e. equivalent to MMI powered-up for more than 1hr in every 4 days, or 2 days in every 6 months)

Memory Card Slot	
Card Type	Type I only (3.3mm thickness) to meet Compact Flash specification
Memory Size Supported	256Mb to 2Gbyte
Hot-Pluggable	No. De-power product prior to insertion or removal.
File System Support	FAT16 - only select FAT16 type when formatting new cards. (Formatted for sector size 512bytes only).
Environmental	
Operating Temperature	0°C to 45°C
Storage & Shipping Temperature	-25°C to 60°C
Enclosure Rating	IP40
Safety	All circuits are SELV
Pollution Degree	Pollution Degree II (non-conductive pollution, except for temporary condensation)
Quality	
Quality Marks	CE (Europe)
Electromagnetic Compatibility	BSEN61800-3 (Drive Specific EMC Standard) Suitable for 1st and 2nd environment applications, restricted-sales distribution class.

Returning the Unit to Parker SSD Drives

Please have the model number, serial number and details of the fault to hand. Contact your nearest Parker SSD Drives Service Centre to arrange return of the item.

You will be given a *Returned Material Authorisation*. Use this as a reference on all paperwork you return with the faulty item. Pack and despatch the item in the original packing materials; or at least an anti-static enclosure. Do not allow packaging chips to enter the unit.

Disposal

This product contains materials which are consignable waste under the Special Waste Regulations 1996 which complies with the EC Hazardous Waste Directive - Directive 91/689/EEC. We recommend you dispose of the appropriate materials in accordance with the valid environmental control laws. The following table shows which materials can be recycled and which have to be disposed of in a special way.

Material	Recycle	Disposal
metal	yes	no
plastics material	yes	no
printed circuit board	no	yes
battery	no	yes

The printed circuit board should be disposed of in one of two ways:

1. High temperature incineration (minimum temperature 1200°C) by an incinerator authorised under parts A or B of the Environmental Protection Act
2. Disposal in an engineered land fill site that is licensed to take aluminium electrolytic capacitors. Do not dispose of in a land fill site set aside for domestic waste.

The Lithium Manganese Dioxide (LiMnO₂) battery should be fully discharged (or the terminals must be taped or capped to prevent short circuit) and taken for treatment and recycling to a designated collection centre, in accordance with the EU Battery Directive.

Packaging

During transport our products are protected by suitable packaging. This is entirely environmentally compatible and should be taken for central disposal as secondary raw material.