



Safe and Comfortable Control

Lift Drive **iV5L**

5.5~22kW 3-Phase 380~480Volts



ISO 14001, ISO 9001





Optimized Solution for Lift Application

Control Lift (Elevator) application with both performance and safety



High Performance Control system

SINCOS / SINCOS+EnDat Encoder, Auto Tuning, Built-In Brake Control, PM and IM control



User-friendly Interface

User-friendly keypad, DriveView management



Dedicated Functions for Lift Application

Safe Torque Off, Fan Control, Automatic Light Load Search, Start-Brake Sequence, Battery run & etc



iV5L

Optimized Solution for Lift Applications

'We guarantee, your satisfaction will be beyond your expectation'

iV5L series realizes the high precision vector control in entire operational area and its highly precise speed control guarantees a superb control stability in the crane, continuous line and Lift system controls.

Safe and Comfortable Control

Lift Drive **iV5L**

NEW

Contents

- 04 Features
- 06 Model and Type
- 07 Specifications
- 09 Wiring
- 10 Terminal Configuration
- 12 Keypad functions
- 13 Peripheral Devices
- 15 Dimensions



ISO 14001, ISO 9001



Features

L Integrated Software for both IM/PM Control

Selectable IM/PM control with embedded keypad

- Induction Motor : V/F, Slip Compensation, Sensored Vector
- Permanent Magnet Motor : Sensored Vector

L Built-in Safe Torque Off (STO)

Disconnects the power based on input signal through redundant safety terminal in case of emergency

- Safety function satisfies EN61508, SIL2(EN13849-1)

L Auto Torque Boost

Open loop control performance secured

L Anti-rollback

Prevents roll back through starting torque compensation by encoder position control when Lift brake opens

L ALLS (Automatic Light Load Search)

Function to allow Lift to run safely in direction with less load in Battery operation (in emergency)

L Anti Hunting Regulation

Constrains current hunting(Current distortion or Oscillation) caused by mechanical resonance under V/F control

L Encoder options

Endat, SIN/COS Encoder Feedback options available

- * Incremental encoder : Default

L Battery Operation

Emergency motor operation using externally installed battery power when main power is not supplied due to power failure (Speed and battery input voltage could be set in battery operation)

L Trip/Warning function

Able to monitor fault by warning and trip setting

- Trip : Fan fault, Battery signal loss during the battery operation, A3 fault, LV2 fault, Safety A/B fault, SINCOS input connection check, Data Clock settings for Endat option board
- Warning : Fan alarm
- Endat encoder fault detection



Option

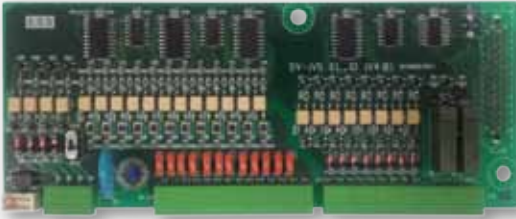

■ Elevator I/O

Embedded with lift sequence program

- Position sensor/Safety switch input
- Car position output
- E/L position and sequence control
- MC/Brake operation signal output
- E/L exclusive connector



■ SIN/COS + Endat encoder option

Option Card for SIN/COS and EnDat encoder

- Selectable Endat & Sin/Cos Option
- Max. 3,600rpm speed
- Enhanced Comfortable feeling in Car
 - Compatibility with Heidenhain Encoder
 - ECN413, ECN1313, ERN487, ERN1387



■ SIN/COS

Option Card for SIN/COS encoder

- Sin/Cos Option
- Max. 130rpm(at 2048 ppr) to 550rpm(at 512 ppr) speed
- Enhanced Comfortable feeling in Car
 - Compatibility with Heidenhain Encoder
 - ECN413, ECN1313, ERN487, ERN1387



Motor Rating	3-Phase 200V
5.5kW (7.5HP)	LSLV055iV5L-4CNNN
7.5kW (10HP)	LSLV075iV5L-4CNNN
11kW (15HP)	LSLV110iV5L-4CNNN
15kW (20HP)	LSLV150iV5L-4CNNN
18.5kW (25HP)	LSLV185iV5L-4CNNN
22kW (30HP)	LSLV220iV5L-4CNNN

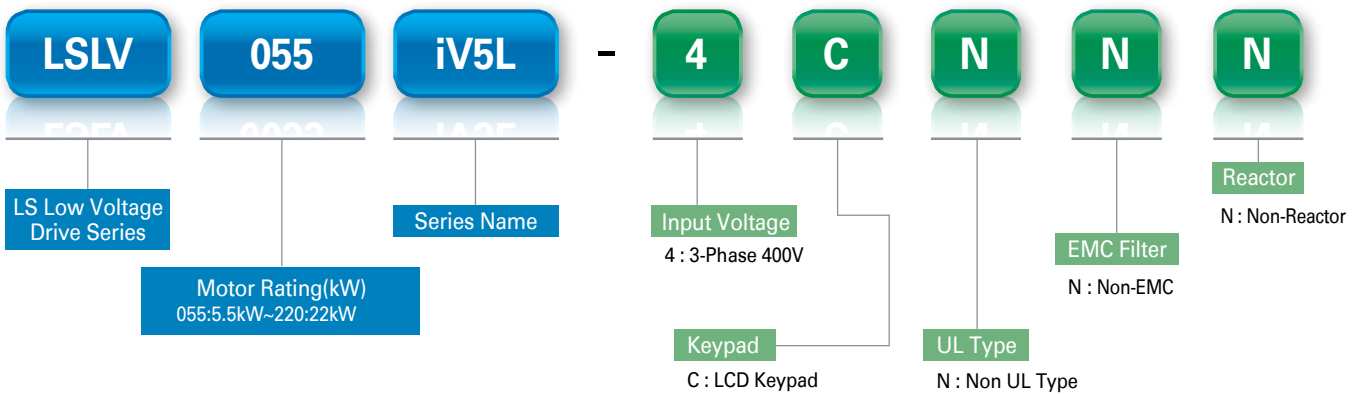
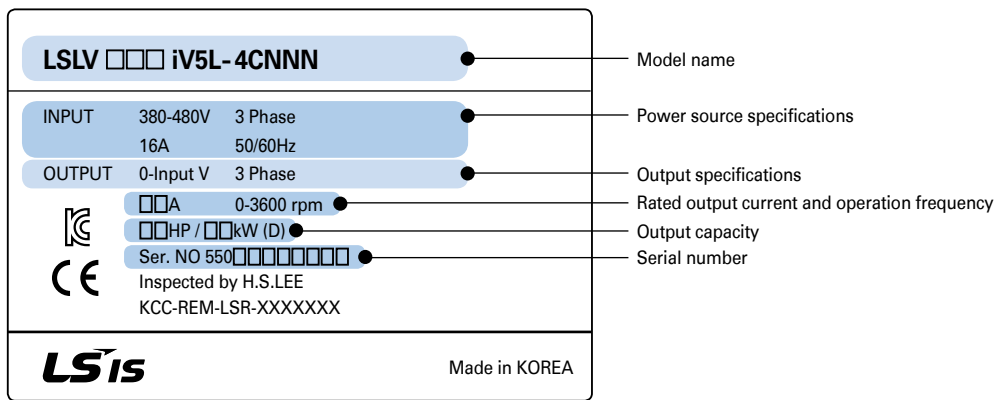

3-Phase 400V (5.5~22kW)

LSLV □□□ iV5L-4CNNN		055	075	110	150	185	220
Motor Rating	HP	7.5	10	15	20	25	30
	kW	5.5	7.5	11	15	18.5	22
Output Rating	Capacity [kVA]	9.1	12.2	18.3	22.9	29.0	34.3
	Rated Current [A]	12	16	24	30	39	45
	Speed	0~3600 rpm					
	Voltage [V]	0~380 V (480V)					
Input Rating	Voltage [V]	3-Phase 380-480 VAC (-10%~+10%)					
	Frequency [Hz]	50~60Hz (±5%)					
	Current [A]	17.5	24	28	35	46	53
Weight (kg(lbs))		7.7 (16.9)	7.7 (16.9)	13.7 (30.2)	13.7 (30.2)	20.3 (44.7)	20.3 (44.7)

- The standard motor capacity is based on a standard 4-pole motor.
- 400V Drives are designed for a 440V supply voltage.
- The maximum output voltage cannot exceed the input voltage.

Control

item	Description	
Circuit system	Voltage type Drive with IGBT	
Control method	Induction motor	Speed (sensored), V/F control, Slip compensation.
	Synchronous motor	Speed (sensored)
Speed control	Analog settings : $\pm 0.1\%$ ($25 \pm 10^\circ\text{C}$) of max speed (1800rpm)	
	Digital settings : $\pm 0.1\%$ ($0 \sim 40^\circ\text{C}$) of max speed (1800rpm)	
Speed setting resolution	Analog settings : $\pm 0.1\%$ of max speed Digital settings : 0.1rpm	
Speed control response speed	50Hz	
Overload capacity	Rated current : 150% 1 min.	
Acceleration / Deceleration	Time settings	0.00 ~600.0 sec
	Combination	4 acceleration/deceleration time choices
	Pattern	Linear, S-Curve

Operation

Braking	Braking method	Resistance discharge braking	
	Braking torque	150%	
	Braking resistor	External braking resistor (installation required)	
Input	Speed configuration	Digital settings via the keypad Analog input settings	Multistep configurations via terminal contact input Option settings
	Analog input	3 channels (AI1, AI2, AI3) - 10 \rightarrow 10V, 10 \rightarrow -10V, 0 \rightarrow 10V, 10 \rightarrow 0V, 0 \rightarrow 20mA, 20 \rightarrow 0 mA motor NTC (only available on AI3) 5 choices of multifunction analog input AI3 : Motor NTC can be used when using Higen motors	
	Terminal contact input	FX, RX, BX, RST, P1, P2, P3, P4, P5, P6, P7 26 function options using the multifunction input terminals (P1-P7).	
Output	Analog output	2 channels (AO1, AO2) - 10 \rightarrow 10V, 10 \rightarrow -10V, 0 \rightarrow 10V, 10 \rightarrow 0V output 30 multifunction analog output options	
	Terminal contact output	Multifunction terminal contact output : 2 channels (1A-1B, 2A-2B) Fault terminal contact output : 1 channels (30A-30C, 30B-30C)	
	Open collector output	1 channel (OC1/EG)	

Protective Function

Trip	Over Current, Ground Fault, Over Voltage, Low Voltage, Over Load, Inv OLT, InvOver Heat, InvThem OP, MotOver Heat, MotThem Err, E-Thermal, External-B, Arm Short, Arm Short-DB, Fuse Open, Encoder Err, BX, Over Speed, COM Error, HW-Diag, EEP Error, FAN Error, BatRUN Fault, Input PO, OUTput PO, SpdDev Err, Low Voltage 2, SAFETY A/B, A3 Safety, ADC Error, Flr/FHM Data, SINCOS Open, ENDAT ERROR
Alarm	Fan alarm, Drive overheat alarm, Motor overheat alarm, Overload alarm

Environment

Surrounding environment	Indoors, prevent contact with direct sunlight and corrosive gases (Pollution Degree 2 Environment).
Ambient temperature	- 10°C~40°C (no icing)
Ambient humidity	Relative humidity less than 90% RH (condensation must not form)
Cooling type	Forced fan cooling structure
Protection structure	IP00
Operation altitude/oscillation	No higher than 3,280 ft (1,000m). Less than 5.9m/sec ² (0.6G).

5.5~22kW (3-Phase)

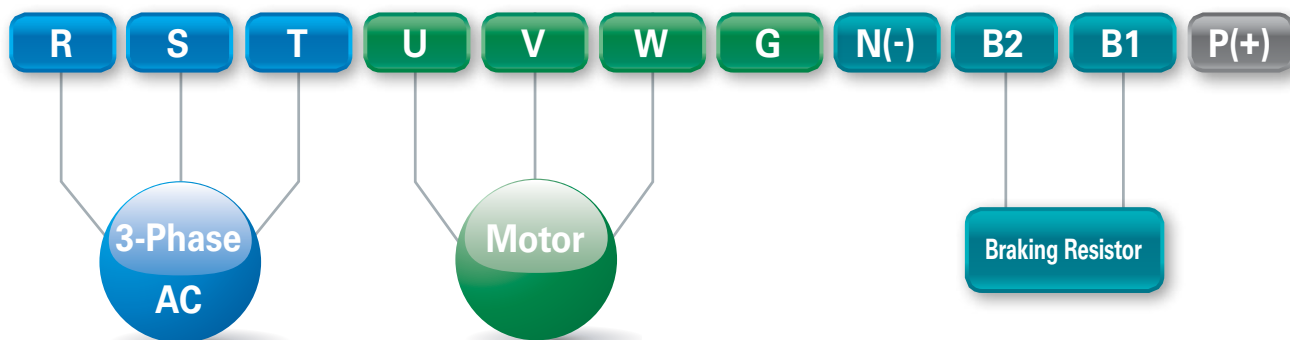

Terminal	Name	Description
R/S/T	AC power input terminals	3-phase AC power connections
U/V/W	Motor output terminals	3-phase motor (induction motor, synchronous motor) wiring connections
G	Ground terminal	Drive frame ground connection (\pm)
B1/B2	Brake resistor terminals	Brake resistor wiring connections
P(+)	DC link terminal P(+)	DC link wiring connections
N(-)	DC link terminal N(-)	

- Apply a DC input to the P (+) and N (-) terminals to operate the drive on DC current input.
- Ground terminal : 5.5~75kW

Input/output terminal screw specifications

Product (kW)		Terminal screw size	Torque (Kgf-cm/Nm)
3-Phase 400V	5.5	M4	7.1~12.2/0.7~1.2
	7.5		
	11	M5	30.6~38.2/3~3.8
	15		
	18.5		
	22		
		M6	61.2~91.8/6~9

Control circuit terminal screw specifications

Terminal	Terminal screw size	Torque (Kgf-cm/Nm)
FX/RX/BX/RST/P1~P7/CM	M2.6	4.0/0.4
Ai1~3/AO1/AO2/5G/A1/B1/A2/B2/OC1/EG	M2	2.2~2.5/0.22~0.25

Ground and power cable specifications

Load (kW)		Ground cable (mm ²)	Power cables (input and output)				
			mm ²	mm ²		AWG	
				R/S/T	U/V/W	R/S/T	U/V/W
3-Phase 400V	5.5	4	4	4	10	10	
	7.5		4	4	10	10	
	11	10	6	6	8	8	
	15		10	10	6	6	
	18.5		16	16	4	4	
	22		16	16	4	4	

5.5 ~ 22kW

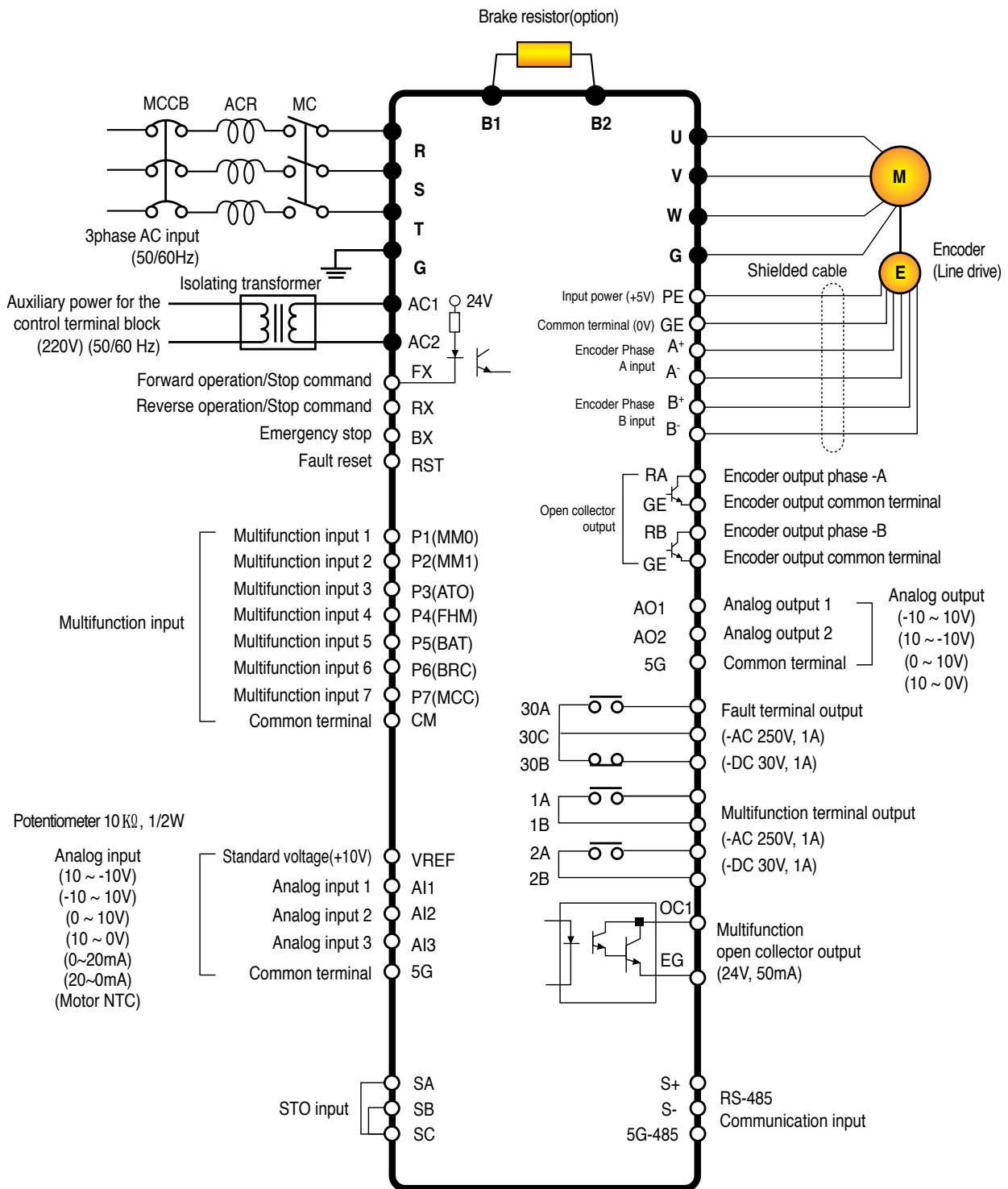

Note) ● : Power terminal ○ : control terminal

Control Circuit Terminal

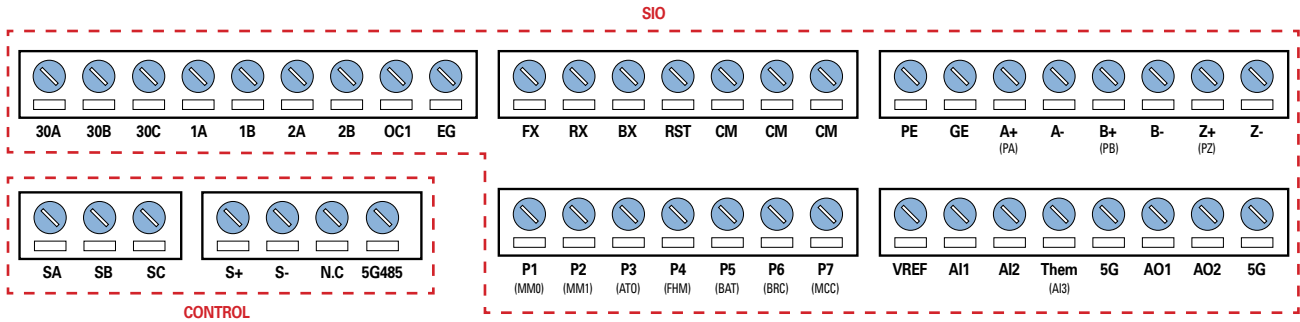

Function	Label	Name	Description
Multifunction terminal configuration	FX	Forward operation/stop command	Stops when FX and RX are ON/OFF at the same time.
	RX	Reverse operation/stop command	
	BX	Emergency stop	Includes free run stop and deceleration stop.
	RST	Fault clearance	Fault status clears when the Drive is ON after the cause of the fault is removed.
	P1 (MIMO)	Multifunction input terminals	Configurable for multifunction input.
	P2 (MIM1)		
	P3 (ATO)		
	P4 (FHM)		
	P5 (BAT)		
P6 (BRC)			
P7 (MCC)			
CM	Common	Common terminal for analog terminal input and output, Function is ON when each Multifunction terminal and CM terminal are connected in NPN input mode.	
Analog input configuration	VREF	Potentiometer for analog input	Used to setup or modify a frequency reference via analog voltage or input current. Maximum output voltage : 10V Potentiometer : 1~10 kΩ
	AI1	Voltage input Current input	Used for input voltage and current applications, or motor NTC. Set jumper to change between voltage, current, or motor NTC input. · For input voltage / AI1, AI2, AI3 : left side · For input current / AI1, AI2 : right side · For input motor NTC / AI3 : right side
	AI2		
	AI3/Them	Voltage input Motor NTC input	
5G	Common	Common terminal for analog terminal input	
Encoder input configuration	PE	Encoder power	+5V Line Drive Power.
	GE		OV
	A+ A-	Encoder Phase A power	Phase A and B signals for the line drive encoder.
	B+ B-	Encoder Phase B power	Set the JP2 switch on the I/O board to "5V" and the JP4 switch to "LD".
	PE	Encoder power	+5V open collector power.
	GE		OV
	PA	Encoder Phase A power	Phase A and B signals for the complementary and open collector encoder.
	PB	Encoder Phase B power	Set the JP2 switch on the I/O board to "15V" and the JP4 switch to "OC"
Z+(PZ)	Encoder Phase Z power	Available only when using an encoder that provides a Phase Z pulse.	
Z-		Line drive type : Using Z+ and Z-, Set JP5 to "LD". Open collector output : Using PZ. Set JP5 to "OC".	

Output/Communication Terminal Labels

Function	Label	Name	Description	
Encoder output	RA	Encoder output Phase-A	The encoder output signals at Phases A and B are open collector outputs.	
	GE	Encoder output common		
	RB	Encoder output Phase-B		
	GE	Encoder output common terminal		
Analog output	AO1	Analog output 1	Output voltage range : · -10V~10V · 10V~-10V · -0V~10V · -10~0V. Select one of the following : · Analog input value · Command before and after acceleration/deceleration · Speed control input command · Motor speed · Speed deviation · Motor speed follow-up · Speed control output · Torque bias · Forward direction torque limit · Reverse direction torque limit · Torque limit during regeneration · Torque command · Torque current command · Torque current · Speed command · Speed current command · Speed current · Q-axis current control output · D-axis current control output · D-axis voltage · Q-axis voltage · Output current · Output voltage · Output power · DC-link voltage · Motor temperature (NTC) · Drive temperature	
	AO2	Analog output 2		
	5G	Common		Common terminal for analog terminal inputs.
Output contacts	1A	1B	Multifunction output contact 1 (Form A contact)	Select one of the following : · Drive operation available · Zero velocity detection · Speed detection · Speed detection (non-polar) · Speed arrival · Timer output · Low voltage alert · In operation · In regeneration · Motor overheat alert · Drive overheat alert · Speed agreement · Torque detection · Torque limit detection · Overheat alert · Stopping · MC output · Fan fault · ALLS status · At constant speed, break output
	2A	2B	Multifunction output contact 2 (Form A contact)	
	OC1	EG	Multifunction open collector output	
	30A		Fault signal (Form A contact)	Output signal is generated when a fault occurs. Does not output when the emergency stop is activated
	30B		Fault signal (Form B contact)	
	30C		Common	
	Switch	JP1	Input pulse encoder	LD (Line Drive) / OC (opencollector or complementary)
JP2		Input voltage encoder	Select between DC +5V, DC+12V, and DC +15V.	
JP4		PNP/NPN input mode	Select PNP/NPN input mode.	

>> Keypad functions

- MODE**
 - Shift between function groups
 - Shifting from group code to the upper code
- PROG**
 - Data set up start
- ENT**
 - Data set up completion
- SHIFT ESC**
 - Decimal point shift
 - Only available in case of data setup
- STOP RESET**
 - Stop command
 - Available with the loader operation
 - LED is turned on when drive stops its operation
 - Blinks when fault occurs
 - Reset
 - Fault reset



- ▲ (up)**
 - Function code shift
 - Shift to next function code
 - Data increase in set up mode
- ▼ (down)**
 - Shift to function code
 - Shift to previous code
 - Data is decreased in set up mode
- REV**
 - Reverse run command key
 - Only available, with loader operation
 - LED is turned ON with reverse run
 - Blinks during Acc/Deceleration of reverse run
- FWD**
 - Forward run command key
 - Only available with loader operation
 - LED is turned on with forward operation
 - Blinks during Acc/Deceleration of forward operation

Loader Use Instruction

Classification	Display	Function Name	Function
KEY	MODE	Mode Key	Shift between groups. Shift from a group code to upper code.
	PROG	Program Key	Parameter setting value change.
	ENT	Enter Key	Saving altered setting values.
	▲ (up)	Up Key	Shift between codes and increase the parameter value.
	▼ (down)	Down Key	Shift between codes and decrease the parameter value.
	Shift/ESC	Shift/ESC Key	In case of set up mode, it is operated with the shift key. Operation with ESC key in non-set up mode.
	REV	Reverse run	Reverse run key.
	STOP/RESET	Stop/Reset Key	Stop key when drive is on operation.
	FWD	Forward Key	Forward run key.
LED	(REV)	Reverse run key	Turns on at reverse operation. Blinks while the drive is on Acc/Deceleration and then turns on the constant speed operation.
	(STOP/RESET)	Stop/Fault display	Turns off when drive stops operation. Blinks when fault occurs.
	(FWD)	Forward Run Display	Turns on during forward operation. Acc/Deceleration running modes blink the lamp and it is turned on in the forward operation.

Peripheral devices

Compatible circuit breakers, leakage circuit breakers, and magnetic contactors (manufactured by LSIS)

Product (kW)		Circuit breaker		Leakage circuit breaker		Magnetic contactor	
		Model	Rated current	Model	Rated current	Model	Rated current
3-Phase 400V	5.5	TD125U	30	EBS 33b	30	MC-22b	22
	7.5		30		30	MC-32a	32
	11		50	EBS 53b	50	MC-40a	40
	15		60	EBS 103b	60	MC-50a	50
	18.5		80		80	MC-65a	65
	22		100		100	MC-65a	65

※ The drive is suitable for use in a circuit capable of delivering no more than 35 kA rms symmetrical amperes at the drive maximum rated voltage, if it is protected with the recommended circuit breaker.

Fuse and reactor specifications

Product (kW)		AC input fuse		AC reactor	
		Current (A)	Voltage (V)	Inductance (mH)	Current (A)
3-Phase 400V	5.5	20	660V	1.22	15
	7.5	30		1.14	20
	11	35		0.81	30
	15	45		0.61	38
	18.5	60		0.45	50
	22	70		0.39	58

※ The DC reactor specifications are not provided because terminals for the DC reactor does not exist in the LSLV-iV5L.

⚠ Caution

Use Class H or RK5 UL listed input fuses and UL listed circuit breakers only. See the table above for the voltage and current ratings for the fuses and breakers.

Braking resistor specifications

The standard for braking torque is 150% and the working rate (%ED) is 5%, If the working rate is 10%, the rated capacity for braking resistance must be calculated at twice the standard.

Product (kW)		Resistance (Ω) ^{Note1)}	Rated capacity (W) ^{Note2)}
3-Phase 400V	5.5	85	800
	7.5	60	1200
	11	40	2400
	15	30	2400
	18.5	20	3600
	22	20	3600

Note 1) ED is based on 100 seconds.

Note 2) Rated capacity is based on the self cooled type.

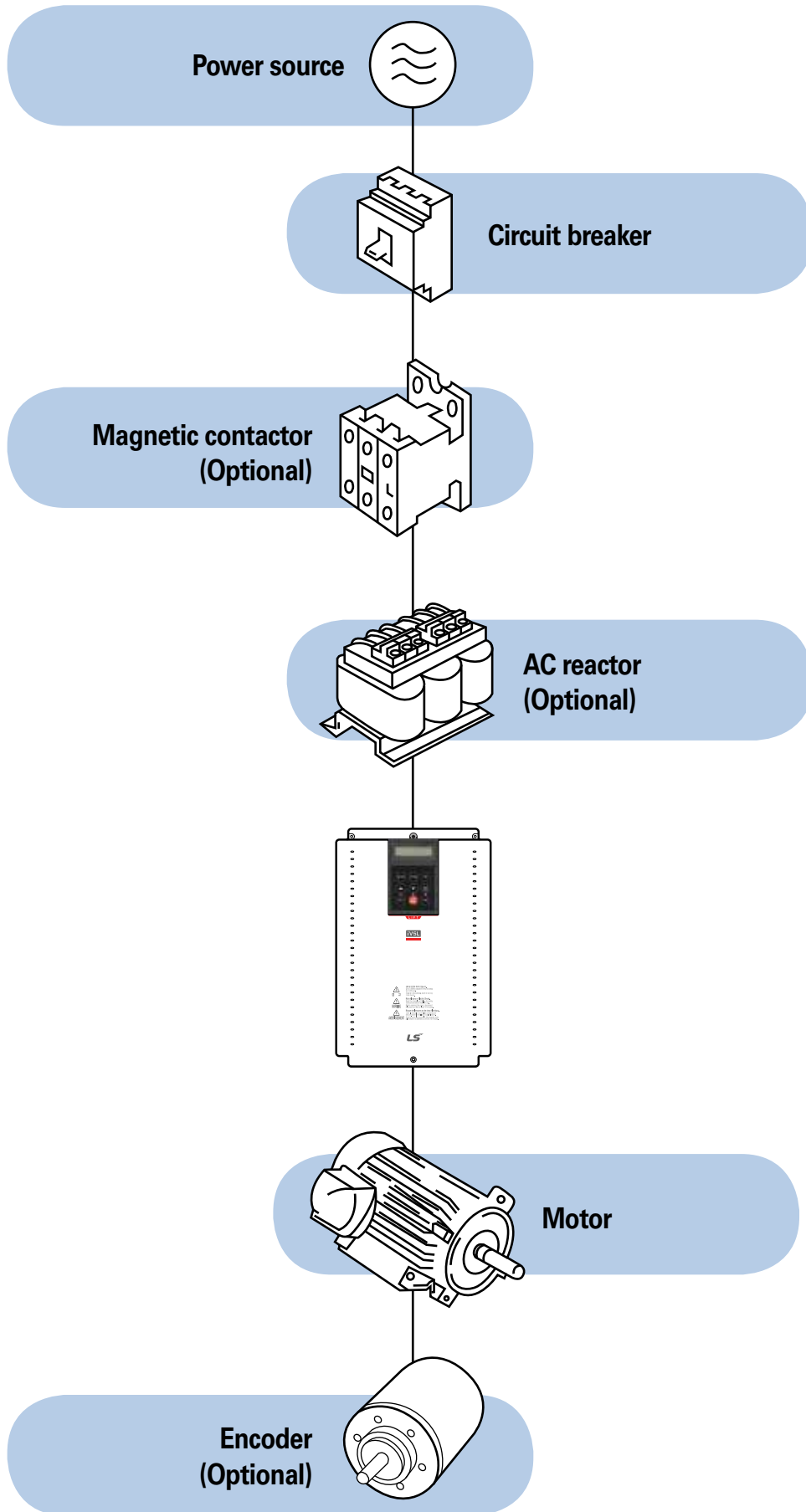

5.5~22kW (3-Phase)

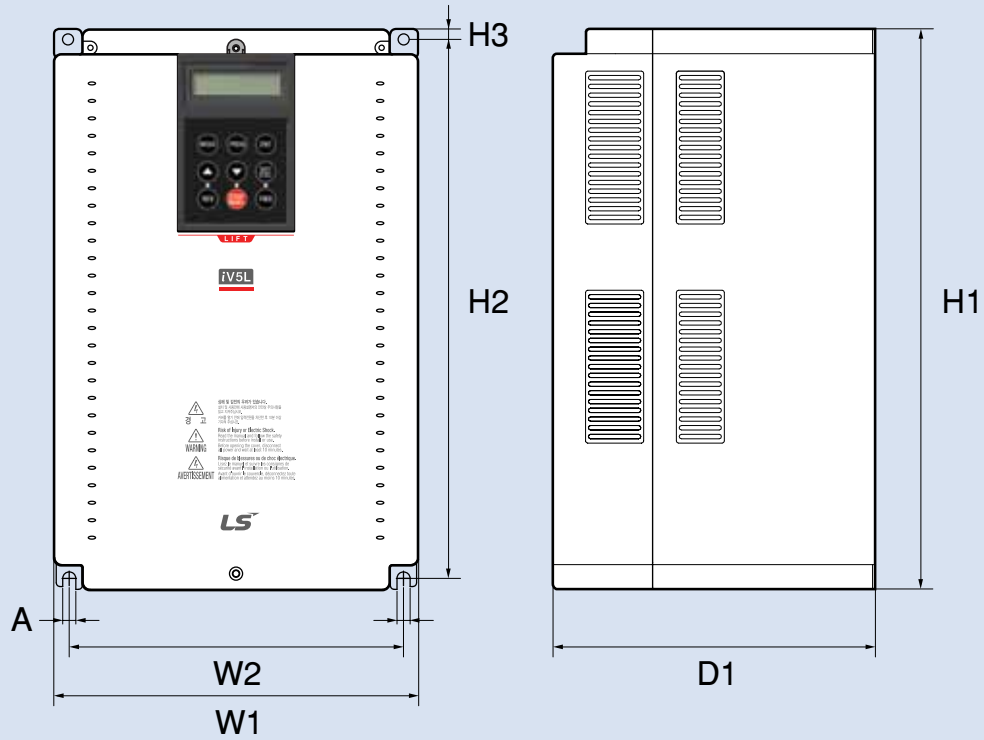

Unit : mm(inches), kg(lbs)

Item		W1	W2	H1	H2	D1	A	weight
3-Phase 400V	LSLV055iV5L-4	200 (7.87)	180 (7.09)	355 (13.97)	340 (13.38)	202 (7.95)	6 (0.24)	7.7 (16.9)
	LSLV075iV5L-4							
	LSLV110iV5L-4	250 (9.84)	230 (9.06)	385 (15.16)	370 (14.57)	221 (8.70)	9 (0.35)	13.7 (30.2)
	LSLV150iV5L-4							
	LSLV185iV5L-4	304 (11.97)	284 (11.18)	460 (18.11)	445 (17.52)	254 (10.00)	9 (0.35)	20.3 (44.7)
	LSLV220iV5L-4							

FUTURING SMART ENERGY



Safety Instructions

- For your safety, please read user's manual thoroughly before operating.
- Contact the nearest authorized service facility for examination, repair, or adjustment.
- Please contact a qualified service technician when you need maintenance. Do not disassemble or repair by yourself!
- Any maintenance and inspection shall be performed by the personnel having expertise concerned.



© 2015.08 LSIS Co., Ltd. All Rights Reserved.

www.lsis.com

■ HEAD OFFICE

LS Tower, 127, LS-ro, Dongan-gu, Anyang-si, Gyeonggi-do, Korea

- EMEA +82-2-2034-4901 / bonseongk@lsis.com
- Asia Pacific / Americas +82-2-2034-4620 / msoo@lsis.com

Overseas Subsidiaries

- **LSIS(Dalian) Co., Ltd. Dalian, China**
No. 15, Liaohexi 3-Road, Economic and Technical Development Zone, Dalian 116600, China
Tel : 86-411-8730-7510 / Fax : 86-411-8730-7560
- **LSIS(Wuxi) Co., Ltd. Wuxi, China**
No. 1, Lexing Road, Wuxi National High & New Tech Industrial Development Area, Wuxi214028, Jiangsu, P.T.China
Tel : 86-510-8534-6666-8005 / Fax : 86-510-8534-4078
- **LS Hukai Electric(Hubei) Co., Ltd. Hubei, China**
No. 100, Tanjahe Road, Dianjun District, Yichang City, Hubei Province, 443004, China
Tel : 86-717-667-7339 / Fax : 86-717-667-7559
- **LS-VINA Industrial Systems Co., Ltd. Hanoi, Vietnam**
Nguyen Khe, Dong Anh, Hanoi, Vietnam
Tel : 84-4-6275-8055 / Fax : 84-4-3882-0220
- **LSIS(ME) FZE Dubai, U.A.E.**
LOB 19-205, JAFZA View Tower, Jebel Ali Free Zone, Dubai, United Arab Emirates
Tel : 971-4-886-5360 / Fax : 971-4-886-5361
- **LSIS Europe B.V. Netherlands**
1st. Floor, Tupolevlaan 48, 1119NZ, Schiphol-Rijk, The Netherlands
Tel : 31-20-654-1420 / Fax : 31-20-654-1429
- **LSIS Japan Co., Ltd. Tokyo, Japan**
Tokyo Club Building 13F, 2-6, Kasumigaseki 3-chome, Chiyoda-ku, Tokyo, 100-0013
Tel : 81-3-6268-8241 / Fax : 81-3-6268-8240
- **LSIS USA Inc. Chicago, U.S.A.**
2000 Millbrook Drive, Lincolnshire, Chicago, IL 60069, United States
Tel : 847-941-8240 / Fax : 847-941-8259

Overseas Branches

- **LSIS Shanghai Office, China**
32nd Floor, International Corporate City, No.3000 NorthZhongshan Road, Putuo District, Shanghai, China, 200063
Tel : 86-21-5237-9977 / Fax : 86-21-5237-7189
- **LSIS Beijing Office, China**
Room 2306, Building B Landgent Center, No.24 Middle Road, East 3rd Ring Road, Chaoyang District, Beijing, P.R. China
Tel : 86-10-5761-3127 / Fax : 86-10-5761-3128
- **LSIS Guangzhou Office, China**
Room 1818-1820, Xinyuan Building, NO.898 Tianhe North Road, Tianhe District, Guangzhou, P.R. China
Tel : 86-20-8326-6784 / Fax : 86-20-8326-6287
- **LSIS Qingdao Office, China**
Room 2001, Galaxy Building, 29 ShanDong Road, ShiNan District, QingDao, ShanDong, P.R. China
Tel : 86-532-8501-6058 / Fax : 86-532-8501-6057
- **LSIS Chengdu Office, China**
Room1710, 17/F Huamin Empire Plaza, NO.1 Fuxin Road, Chengdu, P.R. China
Tel : 86-28-8670-3200 / Fax : 86-28-8670-3203
- **LSIS ShenYang Office, China**
Room 803, Hongyuan Building, 52 South Nanjing Road, Heping District, Shenyang, P.R. China
Tel : 86-24-2321-9050 / Fax : 86-24-8386-7210
- **LSIS Jinan Office, China**
Room 317, Chuangzhan Center, No. 201, Shanda Road, Lixia District, Jinan, Shandong, P.R. China
Tel : 86-531-8699-7826 / Fax : 86-531-8697-7628
- **LSIS Co., Ltd. Tokyo Office, Japan**
Tokyo Club Building 13F, 2-6, Kasumigaseki 3-chome, Chiyoda-ku, Tokyo, 100-0013
Tel : 81-3-6268-8241 / Fax : 81-3-6268-8240
- **LSIS Co., Ltd. Rep. Office, Vietnam**
Gema Dept Tower 18F, 6 Le Thanh Ton, District 1, HCM, Vietnam
Tel : 84-8-3823-7890
- **LSIS Detroit Office, U.S.A.**
5700 Crooks Rd, Suite 211, Troy, MI 48098, USA
Tel : 1-248-792-2637-8 / Fax : 1-248-792-2642
- **LSIS Co., Ltd. India Office, India**
109 First Floor, Park Central, Sector-30, Gurgaon- 122 002, Haryana, India
Tel : 91-1244-930-077 / Fax : 91-1244-930-066
- **LSIS Moscow Office, Russia**
123610, Krasnopresnenskaya, nab., 12, building 1, office №1005, Moscow, Russia
Tel : 7-495-258-1466/1467 / Fax : 7-495-258-1466/1467
- **LSIS U.K. Office, United Kingdom**
G17 Bedford I-Lab, Stannard Way, Priory Business Park, Bedford, MK44 3RZ, U.K.
Tel : 44-012-3483-4774 / Fax : 44-012-3483-4775

Specifications in this catalog are subject to change without notice due to continuous product development and improvement.